

# TS-590S ALC circuit modification procedure

The modification takes approximately 1.5 hours to complete in service centers. The TS-590S uses lead-free solder and multi-layer PCBs, so it should not be carried out by owners / end users.

Serial number range : B09xxxxx to B3Cxxxxx. (From S/No.B4100001 the modification has been applied.)

## STEP 1: Update the firmware to the latest version.

The latest firmware updating program can be downloaded from the following URL.  
[http://www.kenwood.com/i/products/info/amateur/software\\_download.html](http://www.kenwood.com/i/products/info/amateur/software_download.html)

**Note:**

Please update the firmware first before the following hardware modification and re-adjustment, because updating the firmware from "Ver.1.01 or earlier" to "Ver.1.02 or later" revises ALC reference voltage from 2.70V to 2.55V automatically.

## STEP 2: Modify both of the FINAL UNIT and the TX-RX UNIT as follows.

FINAL UNIT : X45-391x-xx (Made in Singapore), or X45-398x-xx (Made in Malaysia)













Ref No.	Status	OLD Part No.	NEW Part No.	Remarks
L255	Change	L33-0695-05	LR79Q0CW222J	1mH → 2.2mH
R20	Change	RS14DB3A470J	RS14DB3A151J	47Ω → 150Ω
R21	Change	RS14DB3A470J	RS14DB3A151J	47Ω → 150Ω
C78→R24	Change	CC73FCH1H470J	RK73FB2B102J	47pF → 1kΩ
R25	Change	RK73FB2B472J	RK73FB2B223J	4.7kΩ → 22kΩ
R26	Change	RK73FB2B472J	RK73FB2B223J	4.7kΩ → 22kΩ
C79→R35	Change	CC73FCH1H470J	RK73FB2B102J	47pF → 1kΩ
R60	Add	-----	RK73GB2A562J	Parallel connection with C51
R61	Add	-----	RK73GB2A562J	Parallel connection with C57
R270	Change	RK73FB2B103J	RK73FB2B000J	10kΩ → 0Ω

TX-RX UNIT : X57-785x-xx (Made in Singapore), or X57-861x-xx (Made in Malaysia)

Ref No.	Status	OLD Part No.	NEW Part No.	Remarks
-----	Add	-----	F20-3320-04	Insulation sheet (2mm x 3mm x 0.05mm)
C810	Change	CE32CL1C100M	CK73FB1C105K	10μF → 1μF
C815	Delete(Move)	CK73GB1H473K	-----	0.047μF → Delete
C815	Add(Move)	-----	CK73GB1H473K	Parallel connection with R817
C830	Add	-----	CK73GB1C474K	Serial connection with R861
D801	Change	EDZ5.1B	EDZV6.2B	5.1V → 6.2V
R728	Change	RK73GB2A331J	RK73GB2A101J	330Ω → 100Ω
R734	Change	RK73GB2A223J	RK73GB2A102J	22kΩ → 1kΩ
R807	Change	RK73GB2A472J	RK73GB2A332J	4.7kΩ → 3.3kΩ
R809	Change	RK73GB2A182J	RK73GB2A222J	1.8kΩ → 2.2kΩ
R825	Change	RK73GB2A104J	RK73GB2A224J	100kΩ → 220kΩ
R861	Add	-----	RK73GB2A470J	Serial connection with C830

### STEP 3: Re-adjust the following Transmitter Section items.

\* In the following table, the figures in bold and underlined are revised from original TS-590S service manual.  
No other items are changed.

Item	Conditions	Measurement Terminal	Adjustment Part	Adjustment Method	Specifications
Final idling current	14.1MHz, USB FINAL UNIT(A/2) VR1,2,3,4:MIN. Transmit	DC IN		Check the default current (I2) of DC IN.	
			VR1	$I2 + 500mA = IA$	$\pm 50mA$
			VR2	$IA + 1000mA = IB$	$\pm 100mA$
			VR3	$IB + \underline{1000mA}^* = IC$	$\pm 50mA$
			VR4	$IC + \underline{1000mA}^* = ID$	$\pm 50mA$
ALC reference Voltage	MENU No.:23 (14.1MHz, USB) Transmit	FINAL UNIT(A/2) TP1(ALC)	[  ] or [  ]	Set the adjustment value within the limit of the specified voltage.	<u><b>2.55V ±0.05V*</b></u>
HF Max. Power (100W)	MENU No.:24 (14.1MHz, CW) Transmit	ANT1	[  ] or [  ]	Set the adjustment value within the limit of the specified power.	100W±3.0W
14.1MHz NULL	MENU No.:24 (14.1MHz, CW) Transmit	FINAL UNIT(A/2) TP2(VSR)	TC1	VSR voltage minimum.	0.3V or less.
50MHz Max. power (100W)	MENU No.:26 (50.1MHz, CW) Transmit	ANT1	[  ] or [  ]	Set the adjustment value within the limit of the specified power.	100W±3.0W
TGC GAIN	MENU No.:36 (14.1MHz, CW) Transmit	ANT1	[  ] or [  ]	Set the adjustment value within the limit of the specified power.	100W±3.0W
ALC meter Start point	MENU No.:37 (14.1MHz, CW) Transmit		[  ]	Push one time.	ALC meter lights up to 1.
ALC meter Zone max. point (15 dots)	MENU No.:38 (14.1MHz, CW) Transmit		[  ]	Push one time.	ALC meter zone max.(15 dots)
Band TGC 1.8~50MHz	MENU No.:40~49 (Each band, CW) Transmit		[  ] or [  ]	Set the adjustment value to become the specified ALC meter.	ALC meter zone max.(15 dots)

**FINAL UNIT (X45-391x-xx, X45-398x-xx) Component side view**

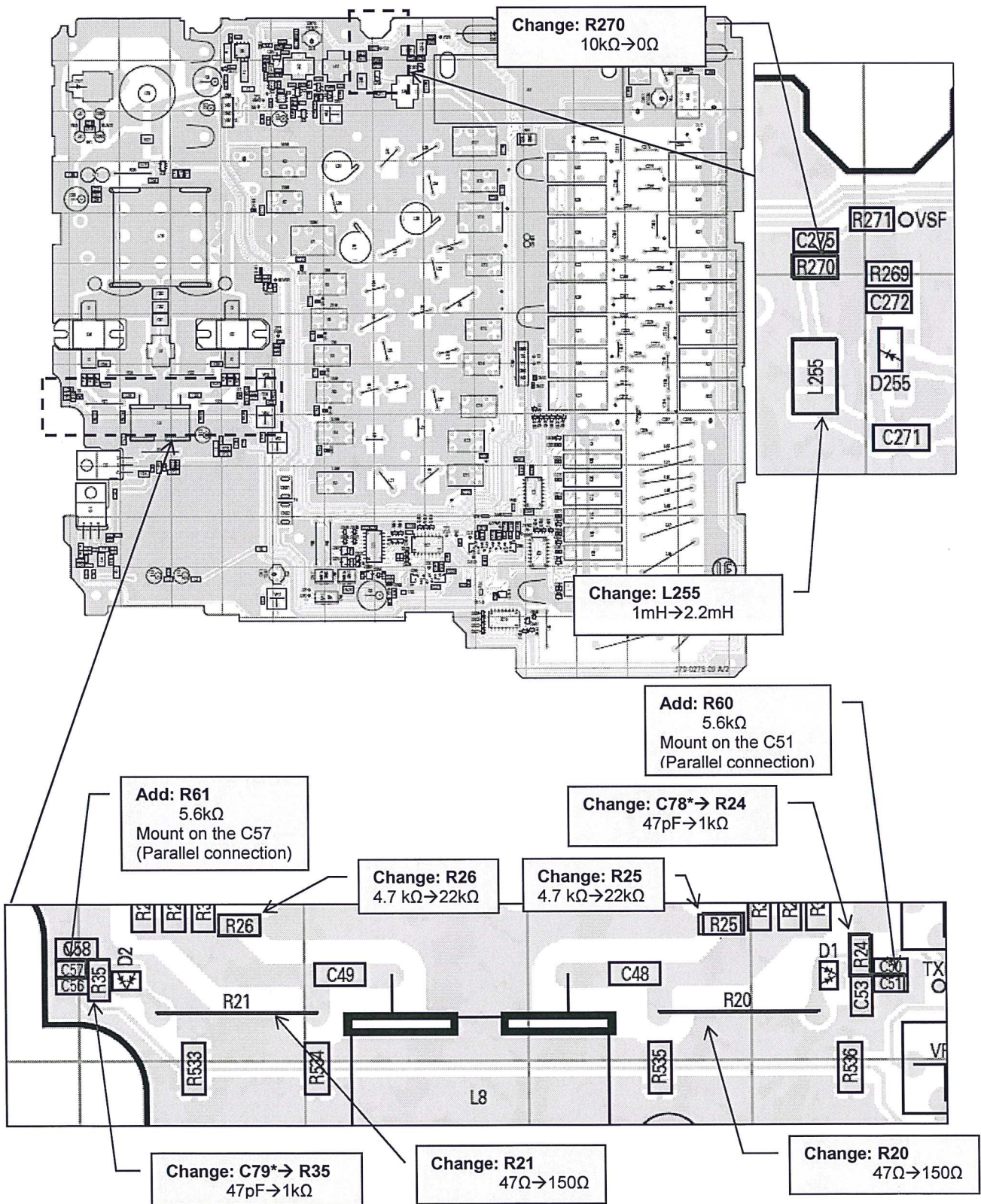

\*In the service manual, 2 x RK73FB2B471J (470Ω) resistors are listed at the location of R24, R35 instead of the actually mounted C78, C79 (47pF). Please replace these capacitors with 1kΩ resistors.

TX-RX UNIT (X57-785x-xx, X57-861x-xx) Component side view

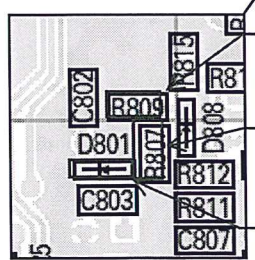
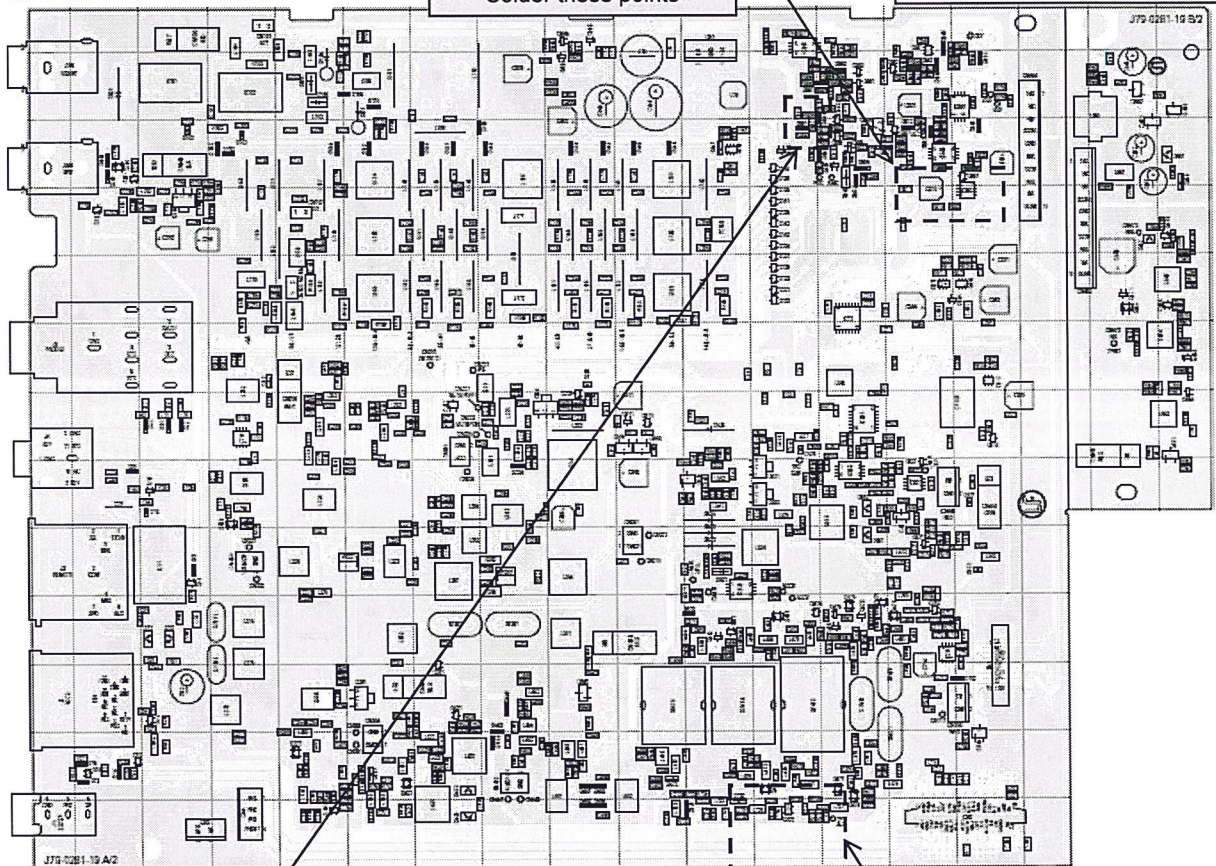
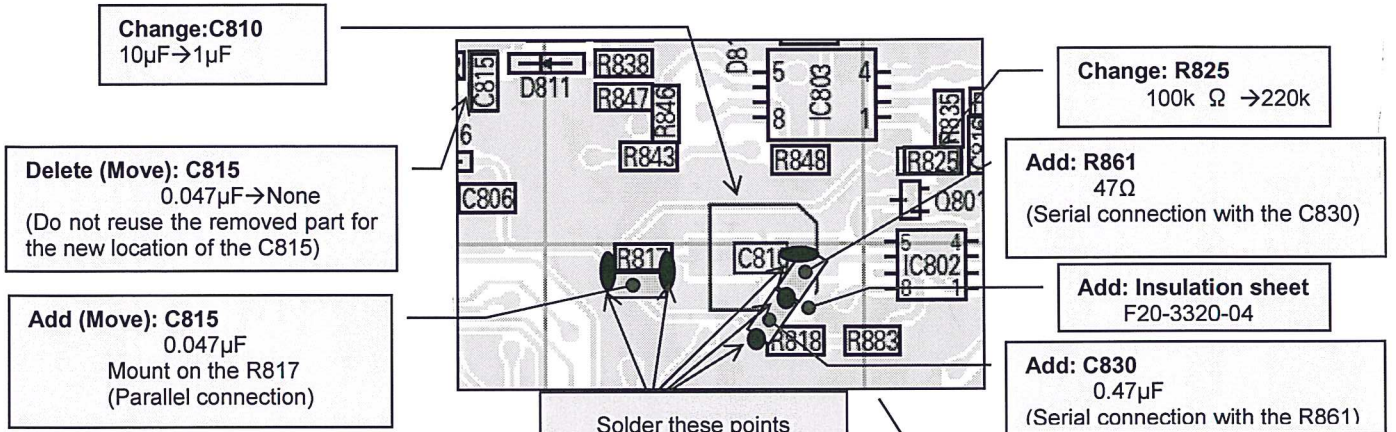

- Change: R809**  
1.8k $\Omega$   $\rightarrow$  2.2k $\Omega$
- Change: R807**  
4.7k $\Omega$   $\rightarrow$  3.3k $\Omega$
- Change: D801**  
5.1V  $\rightarrow$  6.2V
- Change: R728**  
330 $\Omega$   $\rightarrow$  100 $\Omega$

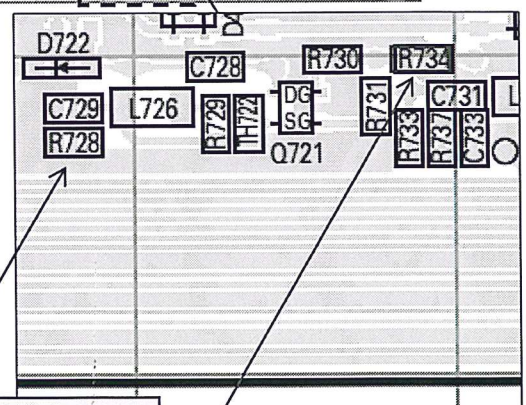

- Change: R734**  
22k $\Omega$   $\rightarrow$  1k $\Omega$

**FINAL UNIT (X45-391x-xx, X45-398x-xx) Schematic diagram**

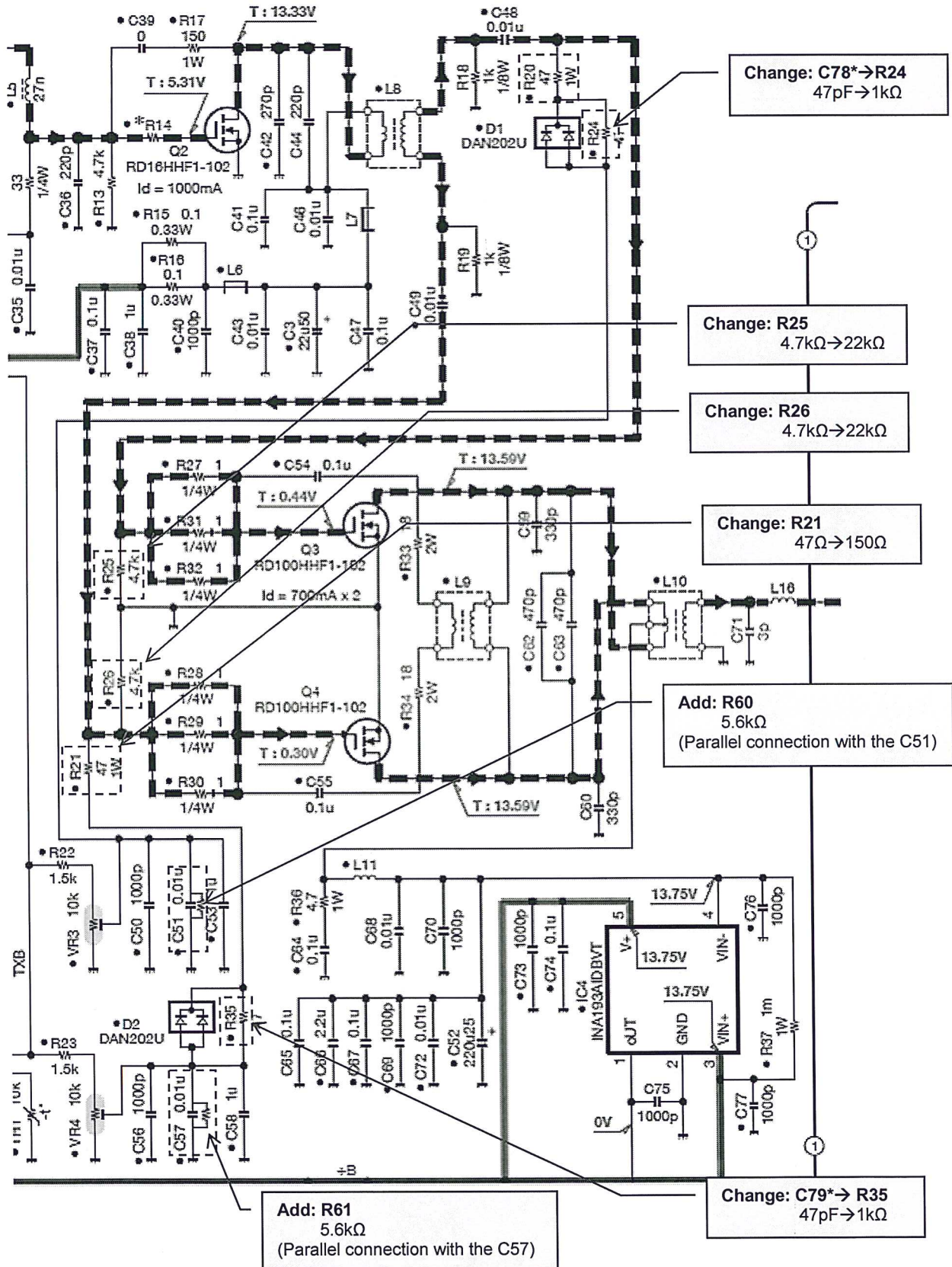

\*In the service manual, 2 x 470Ω (RK73FB2B471J) resistors are listed at the location of R24, R35 instead of the actually mounted C78, C79 (47pF). Please replace these capacitors with 1kΩ resistors.

### FINAL UNIT (X45-391x-xx, X45-398x-xx) Schematic diagram

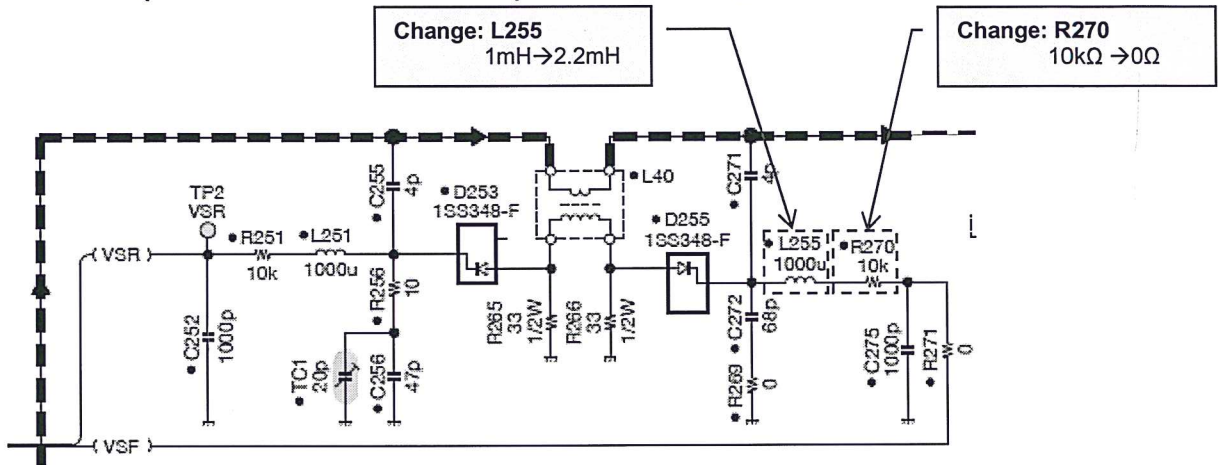

### TX-RX UNIT (X57-785x-xx, X57-861x-xx) Schematic diagram

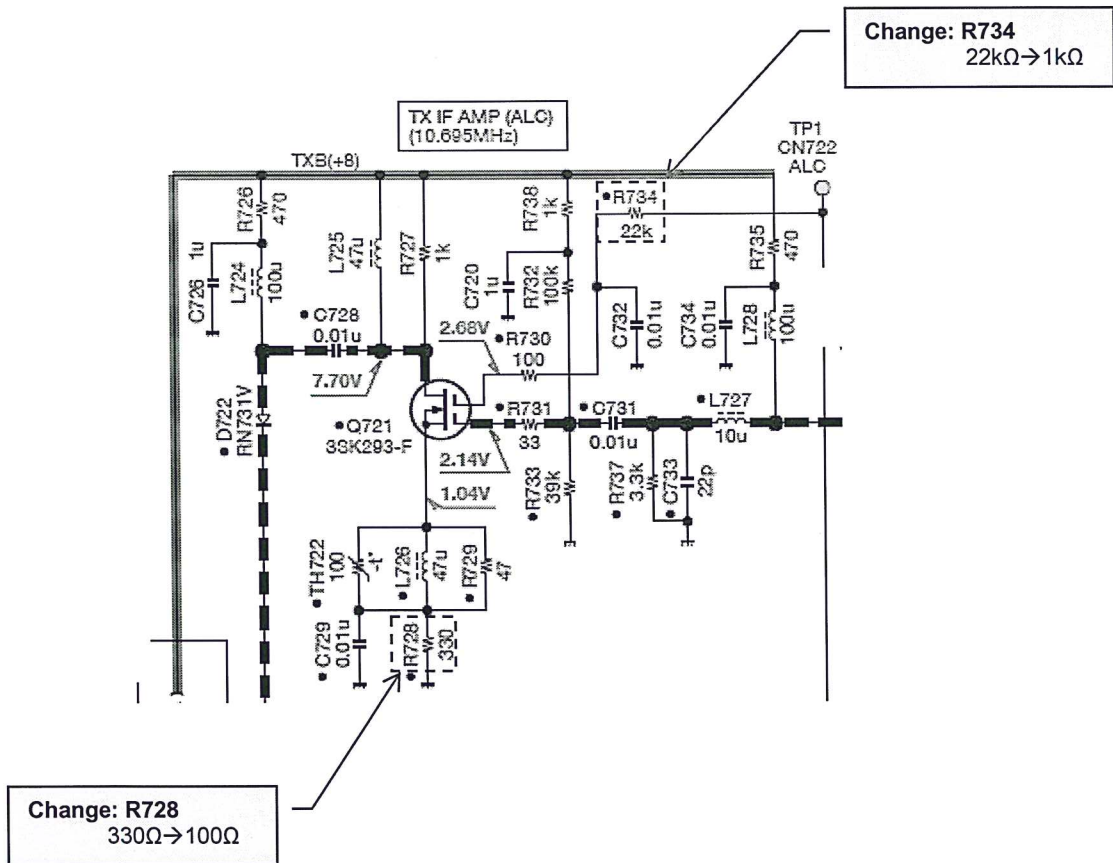

TX-RX UNIT (X57-785x-xx, X57-861x-xx) Schematic diagram

